

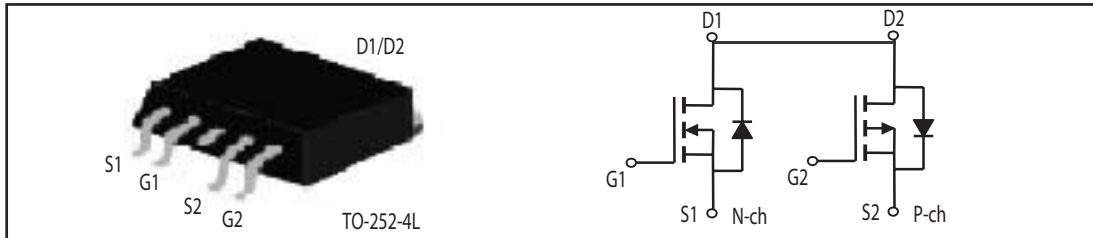

## Dual Enhancement Mode Field Effect Transistor ( N and P Channel)

PRODUCT SUMMARY (N-Channel)		
VDSS	ID	RDS(ON) ( mΩ ) Max
40V	16A	30 @ VGS = 10V
		40 @ VGS = 4.5V

PRODUCT SUMMARY (P-Channel)		
VDSS	ID	RDS(ON) ( mΩ ) Max
-40V	-12A	48 @ VGS = -10V
		65 @ VGS = -4.5V



### ABSOLUTE MAXIMUM RATINGS (TA=25 C unless otherwise noted)

Parameter	Symbol	N-Channel	P-Channel	Unit	
Drain-Source Voltage	VDS	40	-40	V	
Gate-Source Voltage	VGS	±20	±20	V	
Drain Current-Continuous @Tc	ID	25 °C	16	-12	A
		70 °C	13.8	-10	A
-Pulsed <sup>a</sup>	IDM	50	-50	A	
Drain-Source Diode Forward Current	IS	8	-6	A	
Maximum Power Dissipation	PD	Tc= 25 °C	11	W	
		Tc= 70 °C	7.7		
Operating Junction and Storage Temperature Range	TJ, TSTG	-55 to 175		°C	

### THERMAL CHARACTERISTICS

Thermal Resistance, Junction-to-Case	R θC	13.6	°C/W
Thermal Resistance, Junction-to-Ambient	R θA	120	°C/W

# STU404D

N-Channel ELECTRICAL CHARACTERISTICS ( $T_A = 25\text{ }^{\circ}\text{C}$  unless otherwise noted)

Parameter	Symbol	Condition	Min	Typ <sup>c</sup>	Max	Unit
<b>OFF CHARACTERISTICS</b>						
Drain-Source Breakdown Voltage	$BV_{DSS}$	$V_{GS}=0V, I_D=250\mu A$	40			V
Zero Gate Voltage Drain Current	$I_{DSS}$	$V_{DS}=32V, V_{GS}=0V$			1	$\mu A$
Gate-Body Leakage	$I_{GSS}$	$V_{GS}=\pm 20V, V_{DS}=0V$			$\pm 100$	nA
<b>ON CHARACTERISTICS<sup>a</sup></b>						
Gate Threshold Voltage	$V_{GS(th)}$	$V_{DS}=V_{GS}, I_D=250\mu A$	1	1.8	3	V
Drain-Source On-State Resistance	$R_{DS(ON)}$	$V_{GS}=10V, I_D=8A$		22	30	m ohm
		$V_{GS}=4.5V, I_D=6A$		30	40	m ohm
On-State Drain Current	$I_{D(ON)}$	$V_{DS}=5V, V_{GS}=4.5V$	20			A
Forward Transconductance	$g_{FS}$	$V_{DS}=10V, I_D=8A$		20		S
<b>DYNAMIC CHARACTERISTICS<sup>b</sup></b>						
Input Capacitance	$C_{ISS}$	$V_{DS}=25V, V_{GS}=0V$ $f=1.0MHz$		885	1050	pF
Output Capacitance	$C_{OSS}$			105		pF
Reverse Transfer Capacitance	$C_{RSS}$			65		pF
Gate resistance	$R_g$	$V_{GS}=0V, V_{DS}=0V, f=1.0MHz$		0.32		ohm
<b>SWITCHING CHARACTERISTICS<sup>b</sup></b>						
Turn-On Delay Time	$t_{D(ON)}$	$V_{DD}=20V$ $I_D=1A$ $V_{GS}=10V$ $R_{GEN}=3.3\text{ ohm}$		16		ns
Rise Time	$t_r$			12		ns
Turn-Off Delay Time	$t_{D(OFF)}$			28		ns
Fall Time	$t_f$			7		ns
Total Gate Charge	$Q_g$	$V_{DS}=28V, I_D=8A, V_{GS}=10V$		17		nC
		$V_{DS}=28V, I_D=8A, V_{GS}=4.5V$		8.6		nC
Gate-Source Charge	$Q_{gs}$	$V_{DS}=28V, I_D=8A$		2.2		nC
Gate-Drain Charge	$Q_{gd}$	$V_{GS}=10V$		4.8		nC

# STU404D

P-Channel ELECTRICAL CHARACTERISTICS (TA = 25 °C unless otherwise noted)

Parameter	Symbol	Condition	Min	Typ <sup>c</sup>	Max	Unit
<b>OFF CHARACTERISTICS</b>						
Drain-Source Breakdown Voltage	BV <sub>DSS</sub>	V <sub>GS</sub> = 0V, I <sub>D</sub> = -250uA	-40			V
Zero Gate Voltage Drain Current	I <sub>DSS</sub>	V <sub>DS</sub> = -32V, V <sub>GS</sub> = 0V			-1	uA
Gate-Body Leakage	I <sub>GSS</sub>	V <sub>GS</sub> = ±20V, V <sub>DS</sub> = 0V			±100	nA
<b>ON CHARACTERISTICS<sup>a</sup></b>						
Gate Threshold Voltage	V <sub>GS(th)</sub>	V <sub>DS</sub> = V <sub>GS</sub> , I <sub>D</sub> = -250uA	-1	-1.6	-3	V
Drain-Source On-State Resistance	R <sub>DS(ON)</sub>	V <sub>GS</sub> = -10V, I <sub>D</sub> = -6A		40	48	m ohm
		V <sub>GS</sub> = -4.5V, I <sub>D</sub> = -4A		50	65	m ohm
On-State Drain Current	I <sub>D(ON)</sub>	V <sub>DS</sub> = -5V, V <sub>GS</sub> = -10V	-20			A
Forward Transconductance	g <sub>FS</sub>	V <sub>DS</sub> = -10V, I <sub>D</sub> = -6A		12		S
<b>DYNAMIC CHARACTERISTICS<sup>b</sup></b>						
Input Capacitance	C <sub>ISS</sub>	V <sub>DS</sub> = -25V, V <sub>GS</sub> = 0V f = 1.0MHz		980	1150	pF
Output Capacitance	C <sub>OSS</sub>			135		pF
Reverse Transfer Capacitance	C <sub>RSS</sub>			90		pF
Gate resistance	R <sub>g</sub>	V <sub>GS</sub> = 0V, V <sub>DS</sub> = 0V, f = 1.0MHz		2.2		ohm
<b>SWITCHING CHARACTERISTICS<sup>b</sup></b>						
Turn-On Delay Time	t <sub>D(ON)</sub>	V <sub>DD</sub> = -20V I <sub>D</sub> = -1A V <sub>GS</sub> = -10V R <sub>GEN</sub> = 3.3 ohm		12		ns
Rise Time	t <sub>r</sub>			17		ns
Turn-Off Delay Time	t <sub>D(OFF)</sub>			82		ns
Fall Time	t <sub>f</sub>			35		ns
Total Gate Charge	Q <sub>g</sub>	V <sub>DS</sub> = -28V, I <sub>D</sub> = -6A, V <sub>GS</sub> = -10V		20.7		nC
		V <sub>DS</sub> = -28V, I <sub>D</sub> = -6A, V <sub>GS</sub> = -4.5V		11		nC
Gate-Source Charge	Q <sub>gs</sub>	V <sub>DS</sub> = -28V, I <sub>D</sub> = -6 A		1.5		nC
Gate-Drain Charge	Q <sub>gd</sub>	V <sub>GS</sub> = -10V		6.2		nC

# STU404D

ELECTRICAL CHARACTERISTICS ( $T_A=25^{\circ}\text{C}$  unless otherwise noted)

Parameter	Symbol	Condition	Min	Typ <sup>c</sup>	Max	Unit
<b>DRAIN-SOURCE DIODE CHARACTERISTICS<sup>b</sup></b>						
Diode Forward Voltage	$V_{SD}$	$V_{GS} = 0\text{V}, I_S = 8\text{A}$	N-Ch	0.98	1.2	V
		$V_{GS} = 0\text{V}, I_S = -6\text{A}$	P-Ch	-0.9	-1.2	

Notes

a. Pulse Test: Pulse Width  $\leq 300 \mu\text{s}$ , Duty Cycle  $\leq 2\%$ .

b. Guaranteed by design, not subject to production testing.

N-Channel

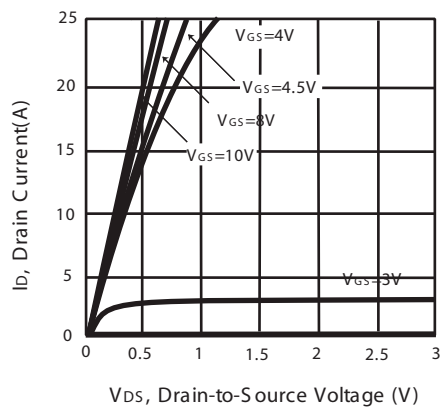

Figure 1. Output Characteristics

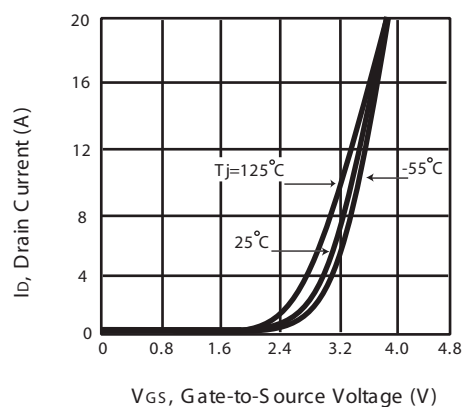

Figure 2. Transfer Characteristics

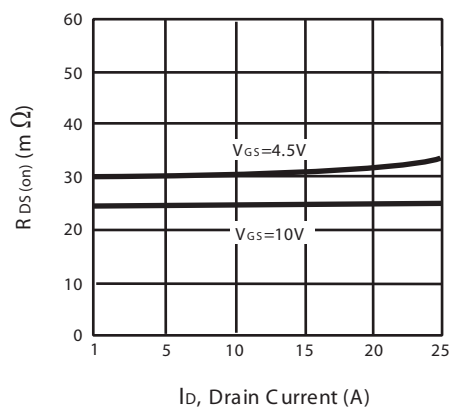

Figure 3. On-Resistance vs. Drain Current and Gate Voltage

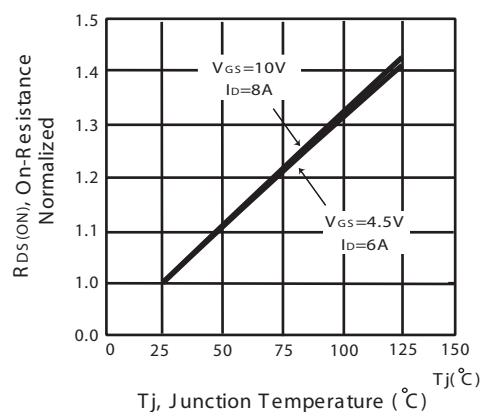

Figure 4. On-Resistance Variation with Drain Current and Temperature

# STU404D

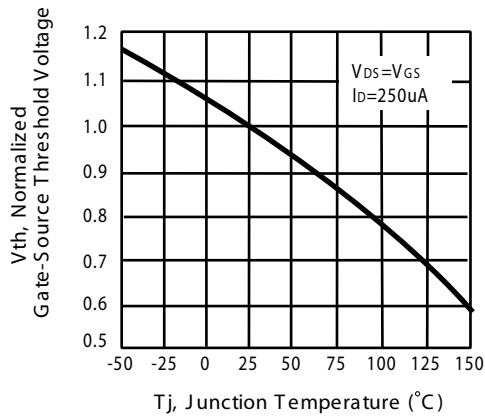

Figure 5. Gate Threshold Variation with Temperature

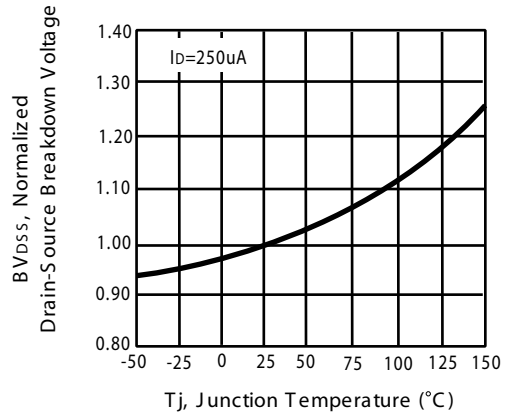

Figure 6. Breakdown Voltage Variation with Temperature

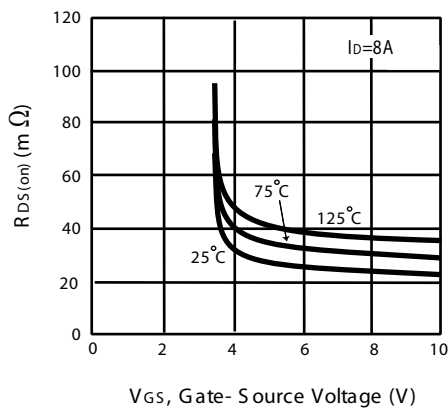

Figure 7. On-Resistance vs. Gate-Source Voltage

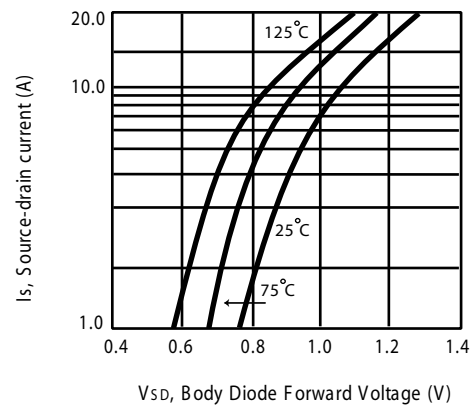

Figure 8. Body Diode Forward Voltage Variation with Source Current

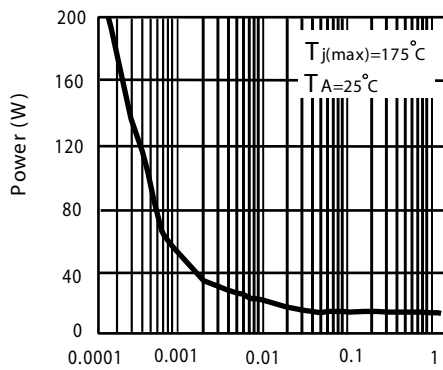

Figure 9. Single Pulse Power Rating Junction-to-Case

# STU404D

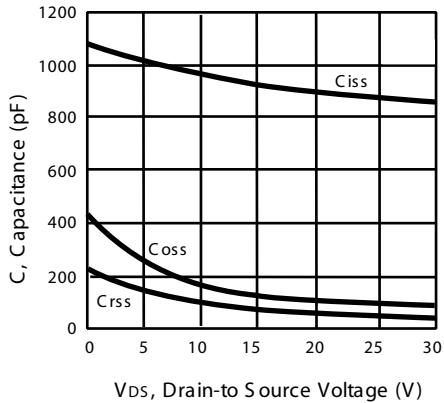

Figure 10. Capacitance

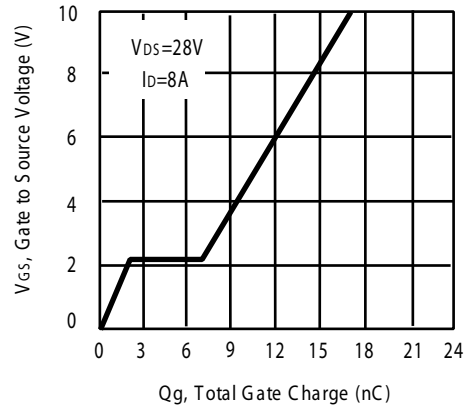

Figure 11. Gate Charge

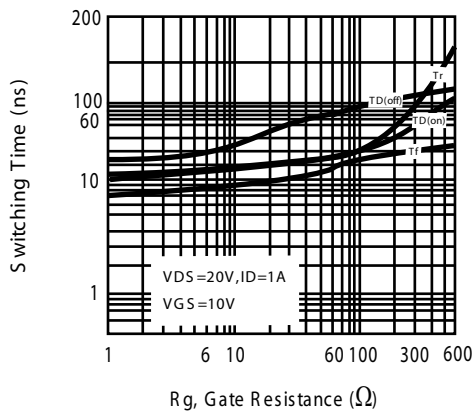

Figure 12. switching characteristics

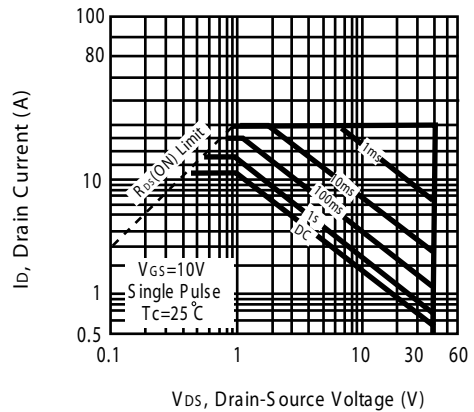

Figure 13. Maximum Safe Operating Area

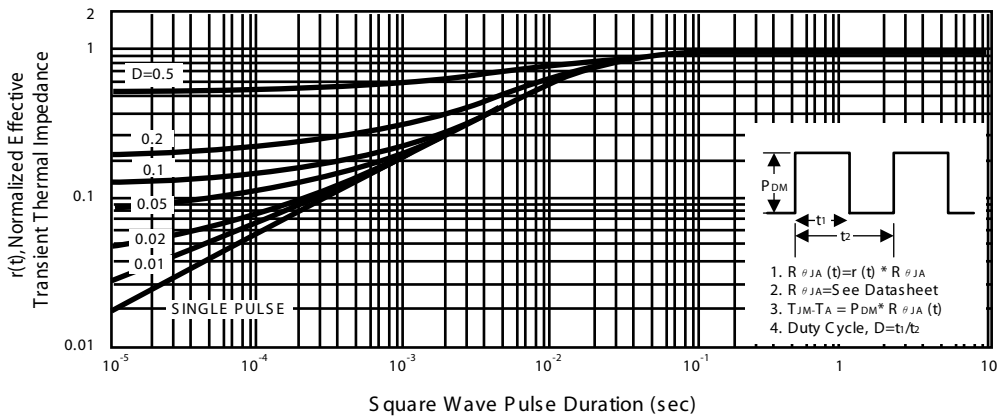

Figure 14. Normalized Thermal Transient Impedance Curve

# STU404D

## P-Channel

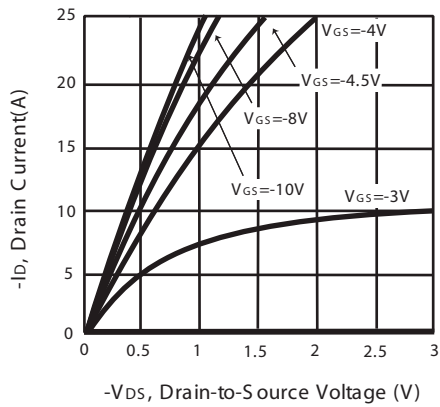

Figure 1. Output Characteristics

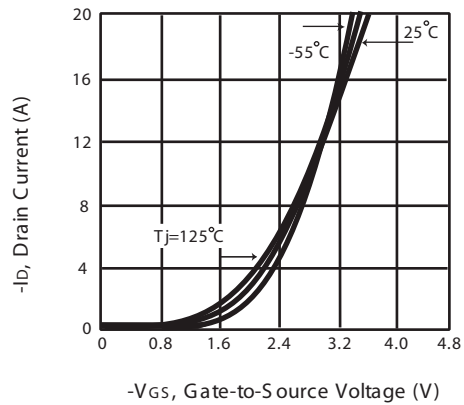

Figure 2. Transfer Characteristics

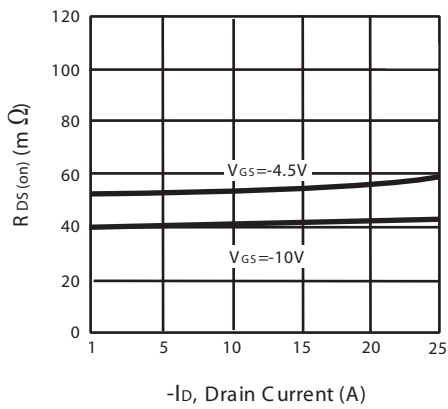

Figure 3. On-Resistance vs. Drain Current and Gate Voltage

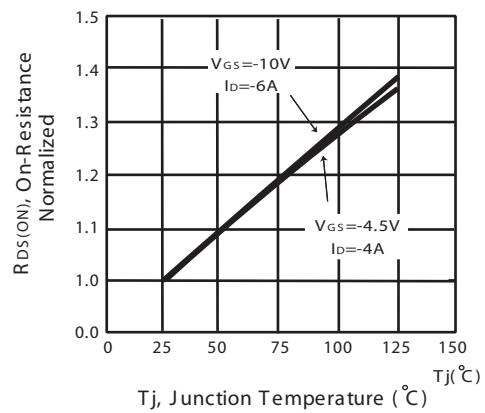

Figure 4. On-Resistance Variation with Drain Current and Temperature

# STU404D

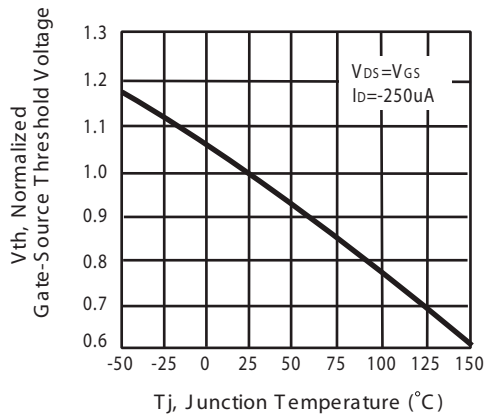

Figure 5. Gate Threshold Variation with Temperature

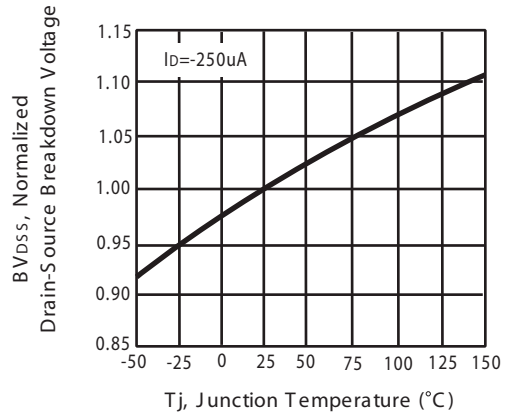

Figure 6. Breakdown Voltage Variation with Temperature

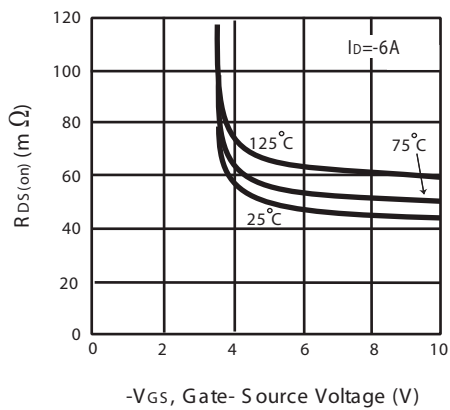

Figure 7. On-Resistance vs. Gate-Source Voltage

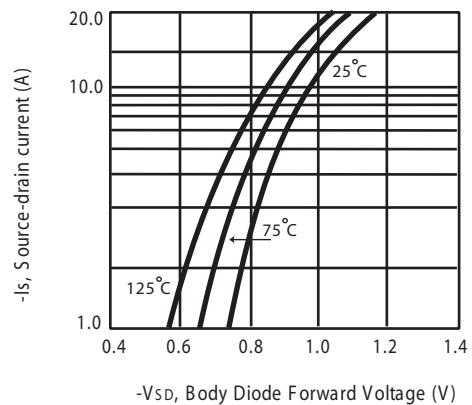

Figure 8. Body Diode Forward Voltage Variation with Source Current

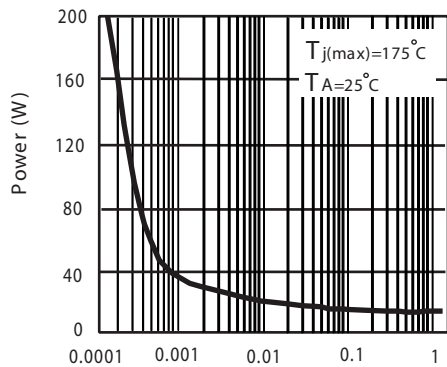

Figure 9. Single Pulse Power Rating Junction-to-Case

# STU404D

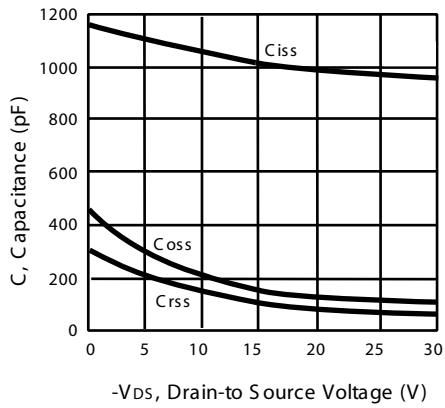

Figure 10. Capacitance

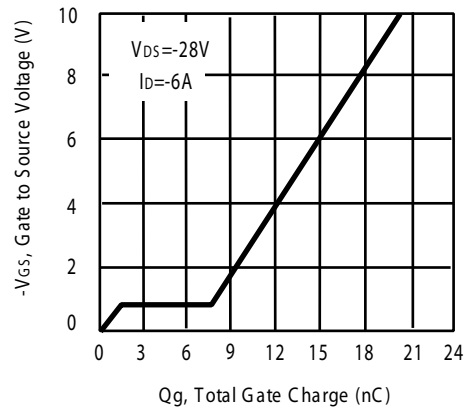

Figure 11. Gate Charge

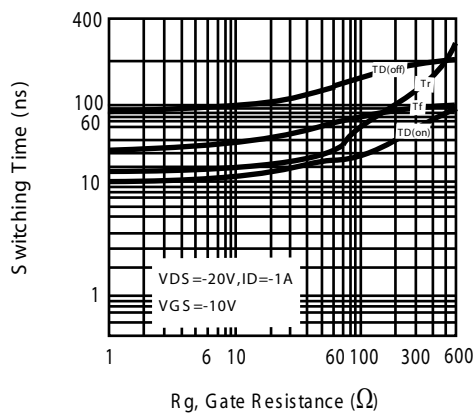

Figure 12. switching characteristics

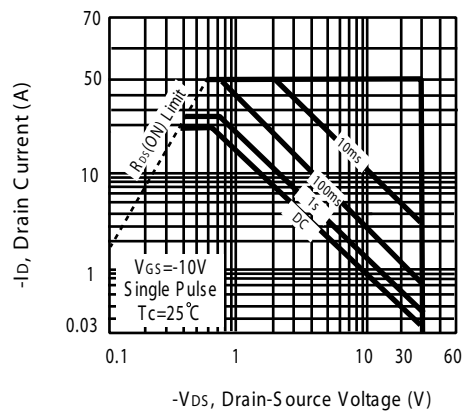

Figure 13. Maximum Safe Operating Area

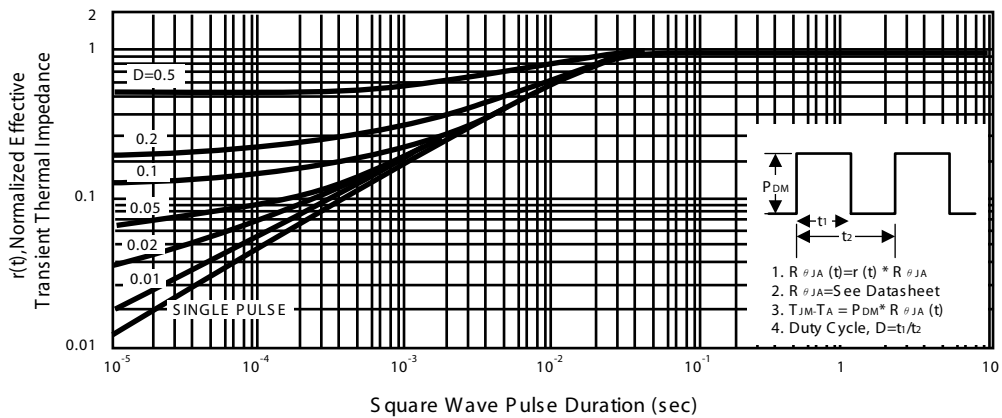
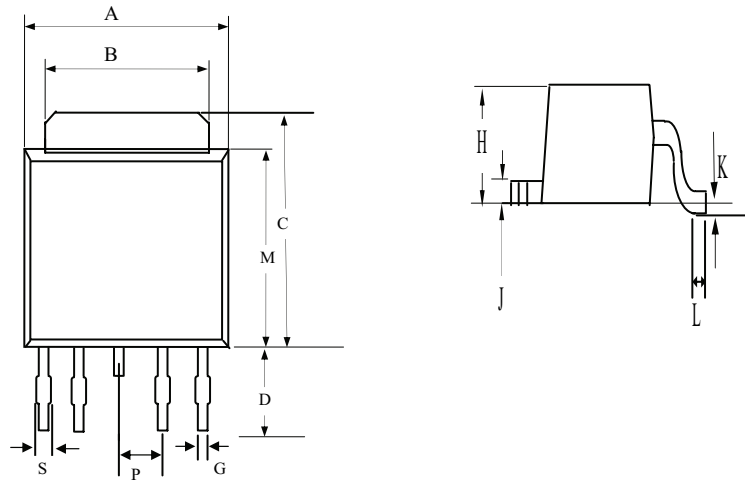

Figure 14. Normalized Thermal Transient Impedance Curve

# STU404D

## PACKAGE OUTLINE DIMENSIONS

TO-252-4L



REF .	Millimeters	
	MIN	MAX
A	6.40	6.80
B	5.2	5.50
C	6.80	10.20
D	2.20	3.00
P	1.27 REF.	
S	0.50	0.80
G	0.40	0.60
H	2.20	2.40
J	0.45	0.60
K	0	0.15
L	0.90	1.50
M	5.40	5.80

# STU404D

## TO-252-4L Tape and Reel Data

### TO-252-4L Carrier Tape

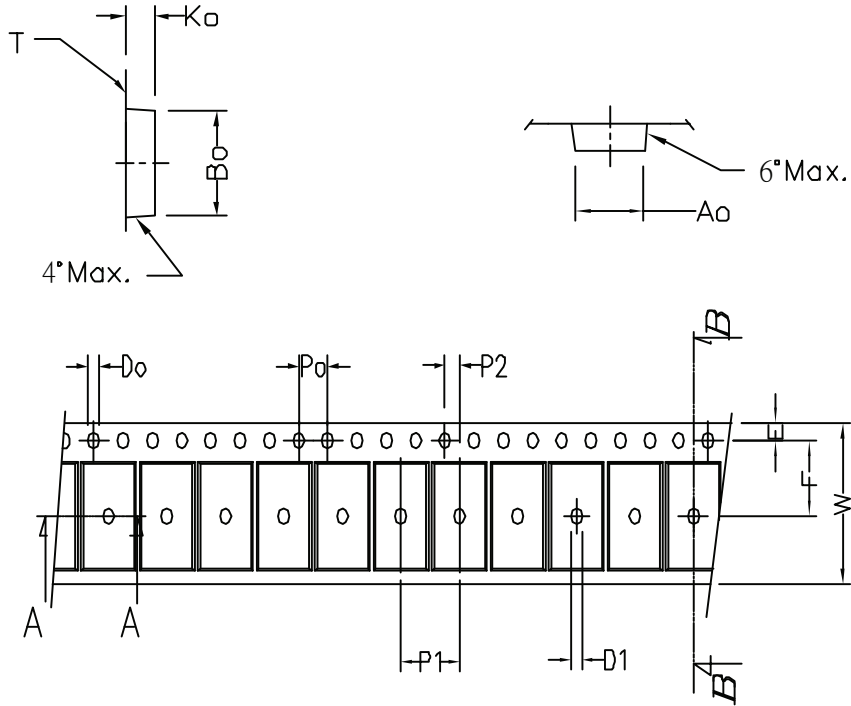

symbol	A <sub>0</sub>	B <sub>0</sub>	K <sub>0</sub>	P <sub>0</sub>	P <sub>1</sub>	P <sub>2</sub>	T
Spec	6.96±0.1	10.49±0.1	2.79±0.1	4.0±0.1	8.0±0.10	2.0±0.05	0.33±0.013
symbol	E	F	D <sub>0</sub>	D <sub>1</sub>	W	10P <sub>0</sub>	
Spec	1.75±0.1	7.5±0.05	1.55±0.05	1.5±0.25	16.0 <sup>+0.3</sup> <sub>-0.1</sub>	40.0±0.2	

### TO-252-4L Reel

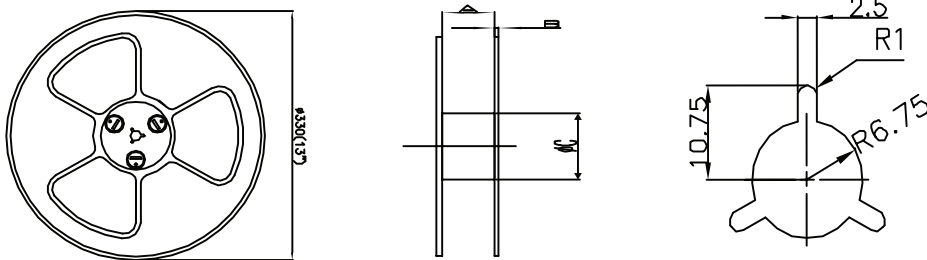

UNIT:mm

Width of carrier tape	8	12	16	24	32	44	56
A±0.1	9.4	13.4	17.4	25.4	33.4	45.4	57.4
B	2.3	2.3	2.3	2.3	2.3	2.3	2.3
∅C	100	100	100	100	100	100	100